

# GIMA

## Multi-Function Electricity Meter

### OPERATOR'S MANUAL



## Technical Assistance

Simpson Electric Company offers assistance Monday through Friday, 8:00am to 4:30pm Central Time. To receive assistance contact Technical Support at (715) 588-3311 or contact us through our web site at [www.simpsonelectric.com](http://www.simpsonelectric.com).

## Warranty and Returns

Simpson Electric Company warrants each instrument and other articles manufactured by it to be free from defects in material and workmanship under normal use and service, its obligation under this warranty being limited to making good at its factory said instrument or other article of equipment which shall within one (1) year after delivery of such instrument or other article of equipment to the original purchaser be returned intact to it, or to one of its authorized service centers, with transportation charges prepaid, and which its examination shall disclose to its satisfaction to have been thus defective; this warranty being expressly in lieu of all other warranties expressed or implied and of all other obligations or liability on its part, and Simpson Electric Company neither assumes nor authorizes any other persons to assume for it any other liability in connection with the sales of its products.

This warranty shall not apply to any instrument or other article of equipment which shall have been repaired or altered outside the Simpson Electric Company factory or authorized service centers, nor which has been subject to misuse, negligence or accident, incorrect wiring by others, or installation or use not in accord with instructions furnished by the manufacturer.



This instrument is designed to prevent accidental shock to the operator when properly used. However, no engineering design can render safe an instrument which is used carelessly. Therefore, this manual must be read carefully and completely before making any measurements. Failure to follow directions can result in a serious or fatal accident.

# Table Of Contents

<b>1. SAFETY</b> .....	<b>4</b>
1.1 WARNING SYMBOLS .....	4
1.2 MAINTENANCE .....	4
<b>2. METER OPERATION</b> .....	<b>5</b>
2.1 MEASUREMENTS .....	5
2.1.1 Balance Current Measurements .....	5
2.1.2 Time Averaged Amps/Volts (T-Avg) .....	6
2.1.3 Maximum Demand Power (MD).....	6
2.2 POWER UP .....	7
2.3 DISPLAY PAGES .....	7
<b>3. DISPLAY PAGES</b> .....	<b>8</b>
3.1 POWER UP .....	8
3.2 CURRENT MENU .....	8-9
3.3 VOLTAGE MENU .....	10-11
3.4 POWER MENU (METER TYPES 1-4) .....	11-14
3.5 RESET OF ENERGY REGISTERS .....	16
3.6 SCROLLING MENU (METER TYPES 1-4).....	16
3.7 METER TYPE DISPLAY MENUS .....	17-18
3.8 DISPLAY SCALING .....	19
3.8.1 Voltage Scaling .....	19
3.8.2 Current Scaling .....	19
3.8.3 Power Scaling (W, VA, var).....	19
3.8.4 Energy Registers (Wh, VAh, varh).....	19
3.8.5 Miscellaneous .....	19
3.9 ISOLATED PULSE OUTPUTS .....	20
<b>4. INSTALLATION</b> .....	<b>21</b>
4.1 PANEL MOUNTING .....	21
4.2 CT CONNECTIONS .....	22
4.3 VOLTAGE CONNECTIONS .....	22
4.4 AUXILIARY MAINS SUPPLY (L & N).....	22
4.5 CONNECTION SCHEMATICS.....	23-25
<b>5. METER SETUP</b> .....	<b>26-28</b>
5.1 PROGRAMMING MENU.....	28
<b>6. OPTIONS</b> .....	<b>28</b>
6.1 INTERNAL MODBUS COMMUNICATIONS .....	28
<b>7. SPECIFICATION</b> .....	<b>29-30</b>

## 1. Safety

### 1.1 Warning Symbols

This manual provides details of safe installation and operation of the meter. Safety may be impaired if the instructions are not followed. Labels on individual meters give details of equipment ratings for safe operation. Take time to examine all labels on the meter and to read this manual before commencing installation.



#### **CAUTION**

Refer to Operating Manual



#### **WARNING**

Danger Risk of Electric Shock

**Figure 1-1 Safety Symbols**

#### **WARNING**

The meter contains no user serviceable parts. Installation and commissioning should be carried out by qualified personnel

### 1.2 Maintenance

The equipment should be maintained in good working order. Damage to the product should be repaired by the manufacturer. The meter may be cleaned by wiping lightly with a soft cloth. No solvents or cleaning agents should be used. All inputs and supplies must be isolated before cleaning any part of the equipment.

## 2. Meter Operation

### 2.1 Measurements

The GIMA makes use of a high speed micro-processor and an Analogue to Digital converter to monitor input signals from three independent phases. Each phase voltage, current and power (kW) are measured directly and a number of other parameters derived from these in software. The measurement process is continuous with all six signals scanned simultaneously at high speed. Unlike many other sampling systems, which sample one phase after another, this ensures that all input cycles are detected. Distorted input waveforms, with harmonics to the 30th are therefore detected accurately.

Derived parameters are calculated and displayed once a second, scaled by user programmed constants for current and voltage transformers.

Instantaneous power parameters are integrated over long time periods providing a number of energy registers. System frequency is detected by digital processing of the phase 1 voltage signal.

#### 2.1.1 Balance Current Measurements

The rms. value of the instantaneous sum of the three phase currents is available on some GIMA meter types. The total current in a three phase system may be represented as :

$$I_{bal} = I_1 + I_2 + I_3 = I_{LEAK} + I_n$$

$I_{LEAK}$  represents any current leaving the system (e.g. Leakage to earth)

$I_n$  represents current in the neutral (4 wire systems only)

**Note: In 3 phase 3 wire systems the GIMA must be wired using 3 current transformers as shown in fig. 4-3 for balance current measurement to be made.**

### 2.1.2 Time Averaged Amps/Volts (T-Avg)

Average values of volts and Amps are calculated over a user programmable time period (10 - 2500 seconds). The displays show the averages for the most recent time period ending at the time the display was last updated. The average period is continuously updated as time progresses.

The largest value of each **T-Avg** parameter is recorded, saved to non-volatile memory and displayed as **Pk hold T-Avg**. These peak values may be reset by the user.

Each **Average-Period** is split into 10 sub-periods. The average values of volts and amps are measured during each sub-period and stored in an array. The latest sub-period values replace the oldest in the array as time progresses. The **T-Avg** values are calculated as the mean of each corresponding array. The display is updated with the latest **T-Avg** parameters at the end of each sub-period (every **Average-Period/10** seconds).

### 2.1.3 Maximum Demand Power (MD)

Average values of kW, kVA and kvar (if fitted) are calculated over a user programmable time period (1 - 60 minutes). The displays show the averages for the most recent time period ending at the time the display was last updated. The demand period is continuously updated as time progresses. These parameters are referred to as **Maximum Demand Powers**.

The largest value of each **MD** parameter is recorded, saved to non-volatile memory and displayed as **Pk hold MD**. These peak values may be reset by the user.

Each **MD-Period** is split into 30 sub-periods. The average power values are measured during each sub-period and stored in an array. The latest sub-period values replace the oldest in the array as time progresses. The MD powers are calculated as the mean of each corresponding array. The display is updated with the latest **MD** values at the end of each sub-period (every **MD-Period/30** seconds).

## 2.2 Power Up

On power up the GIMA shows the meter type and software issue. The example below shows a GIMA 300 with software issue 1.10.

**CUBE  
T - 4  
SOFT 1.10**

## 2.3 Display Pages

To select current measurements press the **AMP** key repeatedly until the desired page is displayed. The number of pages available is dependant on meter type.

To select voltage measurements press the **VOLT** key repeatedly until the desired page is displayed. The number of pages available is dependant on meter type.

To select power/energy measurements press the **POWER** key repeatedly until the desired page is displayed. The number of pages available is dependant on meter type.

Automatically scrolling pages showing PF, Volts & Amps on each phase are obtained by pressing **SCROLL**

Display pages available on the full range of GIMA meters are shown below followed by tables showing those available on each standard meter type.

### 3. Display Pages

Measured data is displayed on the LCD updated every second unless otherwise stated. Display Pages are organized in four Standard Menus as follows:

#### 3.1 Power Up

The following screen is shown when auxiliary power is first supplied.

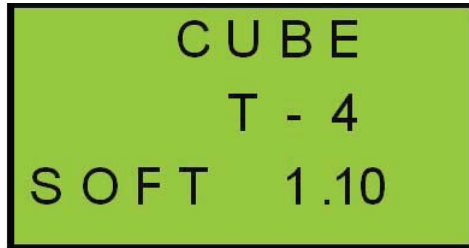

#### 3.2 Current Menu

Press the **AMP** key to select from the available Current Menu pages.

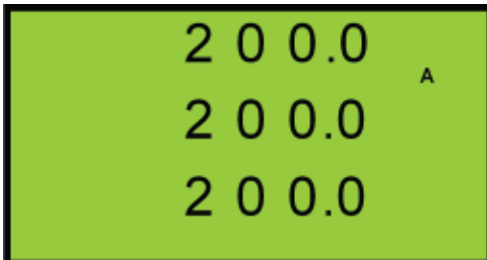

##### **Phase Amps**

##### **All Meter Types**

Phase 1 true rms amps

Phase 2 true rms amps.

Phase 3 true rms amps.

This display is updated every second.

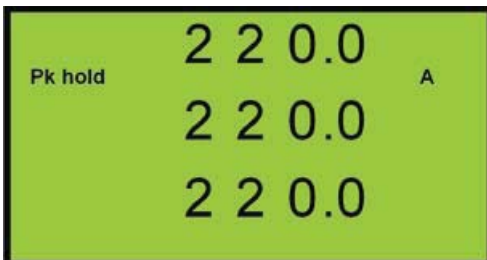

##### **Peak Hold Phase Amps**

##### **G300 & G400 Only**

The maximum value of displayed phase amps. These are stored in non-volatile memory when the meter loses auxiliary power

Press **AMPS** and **VOLTS** to reset all three peaks to zero.

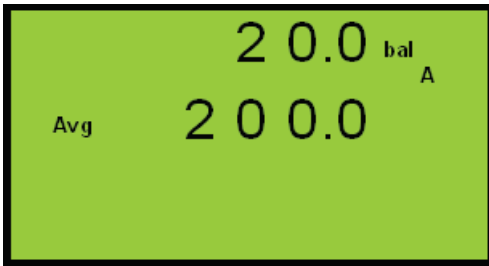

**System and Balance Amps**

**G300 & G400 Only**

Balance Amps - Instantaneous sum of the phase current waveforms. This is a measure of the neutral current + earth leakage.

System Average Amps =  
 $(I_{rms1} + I_{rms2} + I_{rms3})/3.$



**Time-Averaged Amps**

**G100 through G400**

The calculated average of phase amps taken over a user definable time period  $T_{VI}$  (10s to 2500s).

A rolling time window is used and the display updated every  $T_{VI}/10$  with the average of the most recent period displayed.

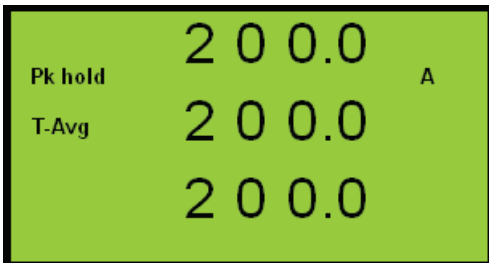

**Peak Time-Averaged Amps**

**G100 through G400**

The maximum value of Time- Averaged amps. These are stored in non-volatile memory when the meter loses auxiliary power

Press **AMP** and **VOLTS** to reset all three peaks to zero.

### 3.3 Voltage Menu

Press the **VOLTS** key to select from the available Voltage Menu pages.

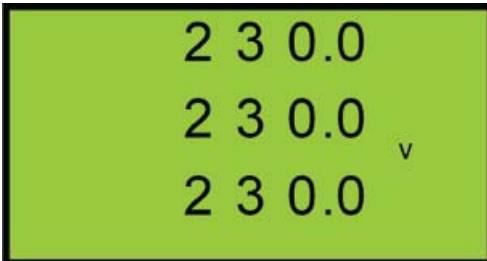

#### **Phase Volts**

##### **All Meter Types**

Phase 1 True rms volts

Phase 2 True rms volts.

Phase 3 True rms volts.

This display is updated every second.

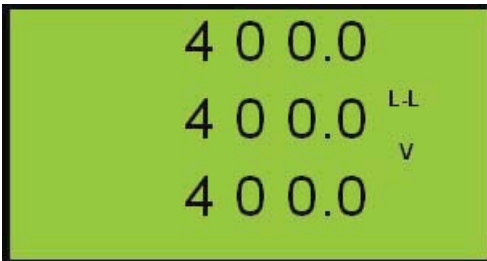

#### **Line Volts**

##### **All Meter Types**

Line 1 Volts (Phases 1-2)

Line 2 Volts (Phases 2-3)

Line 3 Volts (Phases 3-1)

This display is updated every second.



#### **Peak Hold Phase Volts**

##### **Meter Type G300 & G400**

The maximum value of displayed phase volts. These are stored in non-volatile memory when the meter loses auxiliary power

Press **AMP** and **VOLTS** to reset all three maximums to zero.

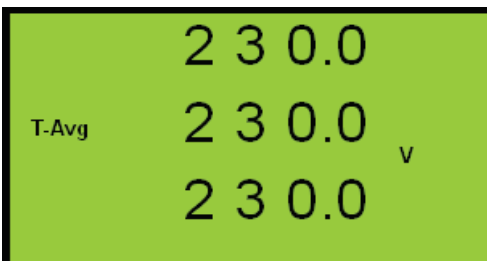

#### **Time-Averaged Volts**

##### **All Meter Types**

The calculated average of phase volts taken over a user definable time period  $T_{VI}$  (10s to 2500s).

A rolling time window is used and the display updated every  $T_{VI}/10$  with the average of the most recent period displayed.

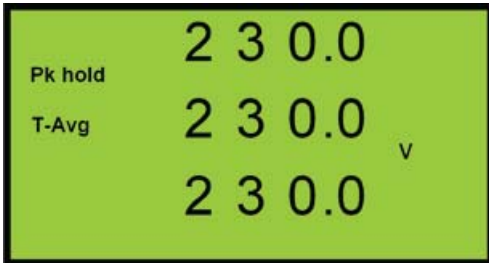

**Peak Time-Averaged Volts**

**All Meter Types**

The maximum value of Time- Averaged volts. These are stored in non-volatile memory when the meter loses auxiliary power

Press **AMP** and **VOLTS** to reset all three maximums to zero.

**3.4 Power Menu (Meter Types G100-G400)**

Press the POWER key to select from the available Power Menu pages.

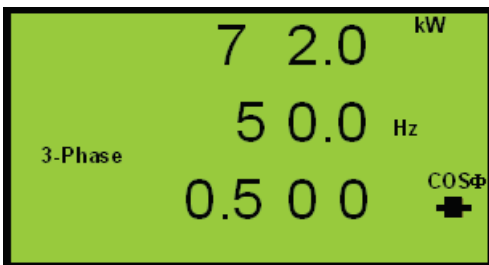

**System Power (kW)**

**Meter Types G100 through G400**

System Real Power (Watts)

Frequency (Measured on V1)

System, PF

A  symbol after the PF value indicates a capacitive load.



**System Power (kVA)**

**Meter Type G400 Only**

System Apparent Power (VA)

Frequency (Measured on V1)

System, PF

A  symbol after the PF value indicates a capacitive load.

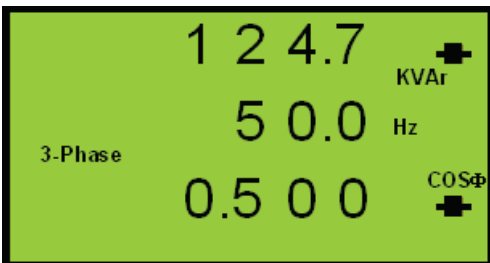

**System Power (kvar)**

**Meter Types G300 & G400 Only**

System Reactive Power (VAr)

Frequency (Measured on V1)

System, PF

A  symbol after the PF and kvar values indicate a capacitive load.

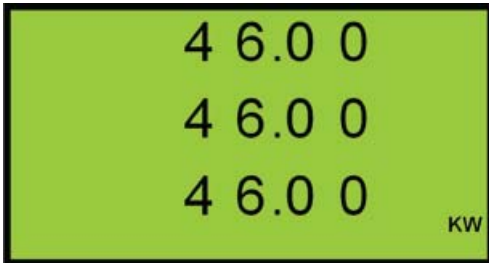

**Phase Watts**

**Meter Types G100 through G400**

- Phase 1 watts
- Phase 2 watts.
- Phase 3 watts

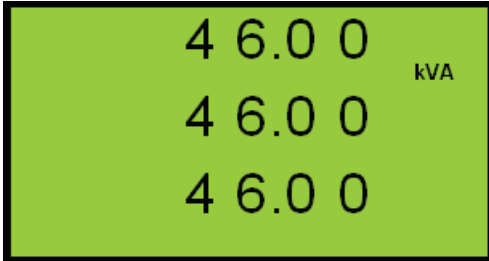

**Phase VA**

**Meter Type G400 Only**

- Phase 1 VA
- Phase 2 VA.
- Phase 3 VA

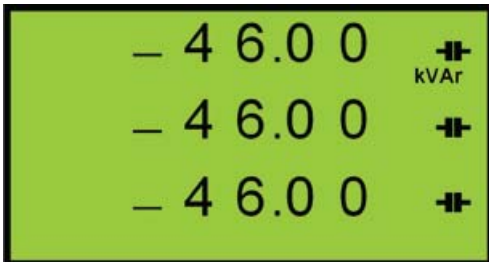

**Phase var**

**Meter Types G300 & G400 Only**

- Phase 1 var
- Phase 2 var.
- Phase 3 var

A  symbol after a var value indicates a capacitive load.

A negative sign before a var reading indicates export reactive power.

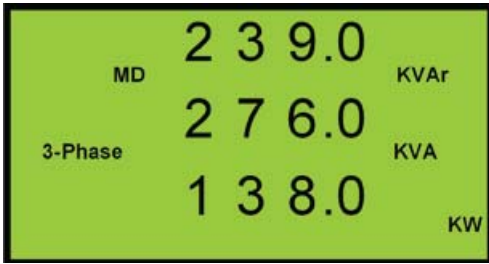

### **Mean Demand (MD)**

#### **Meter Types G300 & G400 Only**

The calculated average of the system power values taken over a user definable time period  $T_p$  (1min to 60min).

A rolling time window is used and the display updated every  $T_p/30$  with the averages of the most recent period displayed.

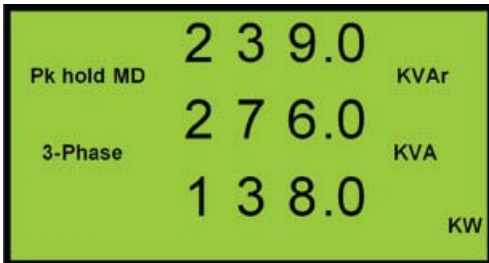

### **Peak Hold MD**

#### **Meter Types G300 & G400 Only**

The maximum value of each power MD value. These are stored in non-volatile memory.

Press **AMP** and **VOLTS** to reset all three maximums to zero. See attached link option on page.

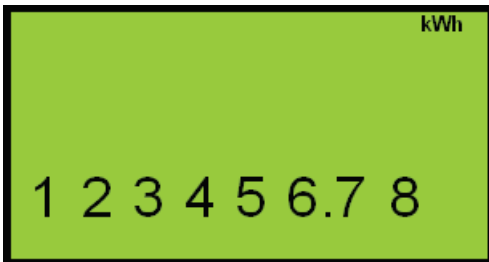

### **Real Energy (Wh)**

#### **Meter Types G200 through G400 Only**

This register accumulates when kW is positive (import).

This value returns to 0 when the value exceeds 99999999.

This register is stored in non-volatile memory when auxiliary power is not supplied to the meter.

\*Press AMP & VOLTS and hold for 5 seconds to reset Kwh to zero if this option is installed.

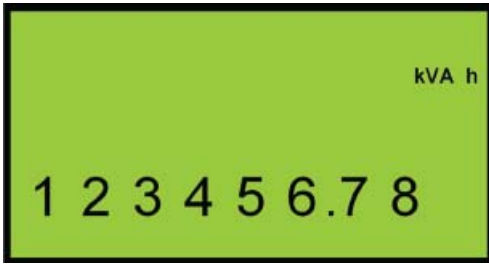

**Apparent Energy (VAh)**

**Meter Type G400 Only**

VAh Accumulating register.

This value returns to 0 when the value exceeds 99999999.

This register is stored in non-volatile memory when auxiliary power is not supplied to the meter.



**Reactive Energy (varh)**

**Meter Type G300 & G400 Only**

Import varh Accumulating register.

This value returns to 0 when the value exceeds 99999999.

This register is stored in non-volatile memory when auxiliary power is not supplied to the meter.

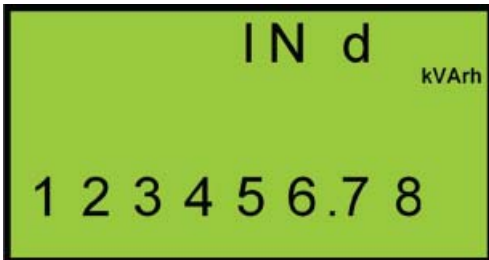

**Reactive Energy Inductive**

**Meter Types G300 & G400 Only**

This register is separate from the main import varh register and accumulates only when the measured load is inductive.

This register resets at 99999999 and is saved in non volatile memory.

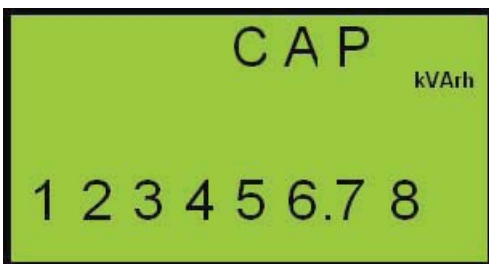

**Reactive Energy Capacitive**

**Meter Types G300 & G400 Only**

This register is separate from the main import varh register and accumulates only when the load is capacitive.

This register resets at 99999999 and is saved in non volatile memory.

**NOTE 1:** Meters may be supplied with all Peak Reset keypad functions disabled.

**NOTE 2:** Meters may be supplied with an Energy Reset Option (ref section 5)

# GIMA Option Links

## 1. Option Links

### WARNING

#### Risk of Electric Shock!

Isolate the instrument supply and all inputs before accessing the option links

Four option links may be accessed on the rear of the GIMA display PCB. Meters are normally shipped with all these links fitted.

**\*Not customer programmable. Contact Simpson before changing.\***

### 1.1 Option Link Detection

For safe operation the instrument supply and all inputs must be isolated before accessing option links. The link settings are only detected during power-up of the auxiliary supply to the meter

### 2. Enable Programming Menu (Link1)

If this link is **removed** the user may not gain access to the programming menu using the front panel keys. For further details of programming the GIMA refer to the meter operating instructions.

### 3. Disable Reset Energy (LINK2)

If this link is **fitted** the Energy Registers may be reset by:

Press **P** to display any energy register

Press **AMP** and **VOLTS** together and hold until energy register resets to zero (approx 5S).

If this link is **removed** the Energy Registers may not be reset

**NOTE:** Once reset to zero the accumulated energy readings may not be recovered.

### 4. Disable Reset Peaks (LINK3)

If this link is **removed** the peak hold and peak demand values may be reset by:

Select any display page showing a Peak Hold or Peak Demand value.

Press **AMP** or **VOLTS** together and hold until the peak value resets to zero (approx 2S).

If this link is **fitted** the peak and peak demand values may not be reset

**NOTE:** Once reset the zero and peak and peak demand values will be replaced by values measured in the following second.

### 5. Pulse Output #2 (LINK4)

If this link is **fitted** the second pulse output will be triggered by changes in the import kvarh register.

If this link is **omitted** the second pulse output will be triggered by changes in the kVah register.

### 3.5 Reset of Energy Registers

Meters may be supplied with an option to reset energy registers to zero using the front keys. If the option is fitted, press **AMP** and **VOLTS** together while displaying any energy register and hold for approximately 3 seconds. All energy registers are simultaneously reset to zero. Once reset the registers may not be recovered.

### 3.6 Scrolling Menu (Meter Types G100 through G400)

Press the **SCROLL** key to select the Auto Scrolling Per-Phase Menu.



#### *Per-Phase Display Pages*

#### *Meter Types G100 through G400*

Three pages show the Amps Volts and Power Factor of phases 1-3 consecutively.

The Phase automatically advances after approximately 5 seconds.

A  symbol indicates a capacitive load.

Press the **SCROLL** key to advance the scrolling pages more quickly.

### 3.7 Meter Type Display Menus

G100 Menu			
AMPS	VOLTS	POWER	SCROLL
Phase Amps	Phase Volts	System Power (kw),Hz,PF	Phase 1 PF, V, I
Time Averaged Amps	Line Volts	Phase Watts	Phase 2 PF, V, I
Peak Time Averaged Amps	Time Averaged Volts		Phase 3 PF, V, I
	Peak Time Averaged Volts		

G200 Menu			
AMPS	VOLTS	POWER	SCROLL
Phase Amps	Phase Volts	System Power (kw),Hz,PF	Phase 1 PF, V, I
Time Averaged Amps	Line Volts	Phase Watts	Phase 2 PF, V, I
Peak Time Averaged Amps	Time Averaged Volts	Import Real Energy (Wh)	Phase 3 PF, V, I
	Peak Time Averaged Volts		

G300 Menu			
AMPS	VOLTS	POWER	SCROLL
Phase Amps	Phase Volts	System Power (kw),Hz,PF	Phase 1 PF, V, I
Time Averaged Amps	Line Volts	System Power (kvar),Hz,PF	Phase 2 PF, V, I
Peak Time Averaged Amps	Time Averaged Volts	Phase Watts	Phase 3 PF, V, I
	Peak Time Averaged Volts	Phase var	
		Maximum Demands (MD)	
		Peak Hold MDs	
		Import Real Energy (Wh)	
		Import Reactive Energy (varh)	
		Reactive Energy Inductive	
		Reactive Energy Capacitive	

<b>G400 Menus</b>			
<b>AMPS</b>	<b>VOLTS</b>	<b>POWER</b>	<b>SCROLL</b>
Phase Amps	Phase Volts	System Power (kw),Hz,PF	Phase 1 PF, V, I
Peak Hold Phase Amps	Line Volts	System Power (kVA),Hz,PF	Phase 2 PF, V, I
System and Balance Amps	Peak Hold Phase Volts	System Power (kvar),Hz,PF	Phase 3 PF, V, I
Time Averaged Amps	Time Averaged Volts	Phase Watts	
Peak Time Averaged Amps	Peak Time Averaged Volts	Phase VA	
		Phase var	
		Maximum Demands (MD)	
		Peak Hold MDs	
		Import Real Energy (Wh)	
		Apparent Energy (VAh)	
		Import Reactive Energy (varh)	
		Reactive Energy Inductive	
		Reactive Energy Capacitive	

### 3.8 Display Scaling

Measured values displayed on the LCD are scaled by the user settings of CT and/or PT primaries to provide optimum resolution.

#### 3.8.1 Voltage Scaling

PT Setting	Resolution
10V <sub>L-L</sub> - 80V <sub>L-L</sub>	0.01 V
81V <sub>L-L</sub> - 800V	0.1 V
801V <sub>L-L</sub> - 8,000V <sub>L-L</sub>	1 V
8,001V <sub>L-L</sub> - 80,000V <sub>L-L</sub>	0.01 kV
>80,000V <sub>L-L</sub>	0.1kV

#### 3.8.2 Current Scaling

CT Setting	Resolution
5A - 8A	0.001 A
9A - 80A	0.01 A
81A - 800A	0.1 A
801A - 8,000A	1 A
>8,000A	0.01 kA

#### 3.8.3 Power Scaling (W, VA, var)

PT Setting x CT Setting	Phase Parameters	System Parameters
100VA - 1,400VA	0.1 W	0.001 kW
1,401VA - 14,000VA	0.001 kW	0.01 kW
14,001VA - 140,000VA	0.01 kW	0.1 kW
140,001VA - 1,400,000VA	0.1 kW	1 kW
1,400,001VA - 14,000,000VA	1 kW	0.01 MW
14,000,001VA - 140,000,000VA	0.01 MW	0.1 MW
140,000,001VA - 1,000,000,000VA	0.1 MW	1 MW

#### 3.8.4 Energy Registers (Wh, VAh, varh)

PT Setting x CT Setting	Resolution
100VA - 1,400VA	.001 kWh
1,401VA - 14,000VA	0.01 kWh
14,001VA - 140,000VA	0.1 kWh
140,001VA - 1,400,000VA	1 kWh
1,400,001VA - 14,000,000VA	0.01 MWh
14,000,001VA - 140,000,000VA	0.1 MWh
140,000,001VA - 1,000,000,000VA	1 MWh

#### 3.8.5 Miscellaneous

All Settings	Resolution
System and Phase PF	0.001
THD	0.1%
Harmonics	0.1%
Frequency	0.1 hz

### 3.9 Isolated Pulse Outputs

GIMA meters which display kWh and/or kvarh incorporate isolated pulse output(s). These outputs provide a simple interface to external systems such as building management centres etc.

Each output takes the form of a normally open, volt free contact pair which provides a low resistance, for 100mS, at the end of a pre-set number of increments of the associated energy register ('pulse rate'). The pulse rate of each output may be programmed by the user to match the requirements of the external system. For further details on programming the GIMA refer to Section 5.

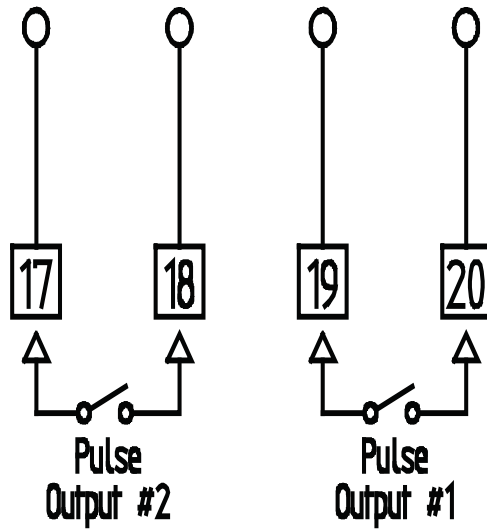

Figure 2.1 Pulse Output Connection



## 4.2 CT Connections

The GIMA is designed for use with external current transformers (CTs). Recommended types should conform to Class 1 per IEC 60044-1. The secondary of the CT should be specified to suit the input rating defined on the meter label. Cables used for the current circuit should have a maximum conductor size of 4.0mm<sup>2</sup> and should be kept as short as possible to reduce cable losses loading the CT secondary.

CT Inputs to the meter are isolated from each other and all other parts of the circuit. This allows use on a wide variety of systems including those requiring common and/or earthed CT secondaries.

### **WARNING :**

**NEVER** leave the secondary of a current transformer open circuit while a primary current flows. In this condition dangerous voltages may be produced at the secondary terminals.

## 4.3 Voltage Connections

Cables used for the voltage measurement circuit should be insulated to a minimum of 600V AC and have a minimum current rating of 250mA. The maximum conductor size is 4.0mm<sup>2</sup>.

External protection fuses are recommended for the voltage measurement inputs. These should be rated at 160mA maximum, Type F, and should be able to withstand voltages greater than the maximum input to the meter.

## 4.4 Auxiliary Mains Supply (L & N)

The GIMA uses an isolated auxiliary mains supply separate from the voltage measurement inputs. This may be connected separately or in parallel with the measurement inputs provided the ratings detailed on the instrument label are not exceeded.

Separate connection of the auxiliary mains is required, for example, when :

- A suitable supply voltage is not available locally.
- Measurement voltages are expected to vary over a wide range
- A backup supply is required to maintain meter display

The auxiliary mains supply is not internally fused. External fusing is required to protect the meter. External fuses should be rated at 250mA 250V Type T. The meter ratings are detailed on the instrument label.

### **WARNING :**

**CHECK** the instrument **LABELS** for correct input ratings. Incorrectly rated inputs may permanently damage the device.

# 4.5 Connection Schematics

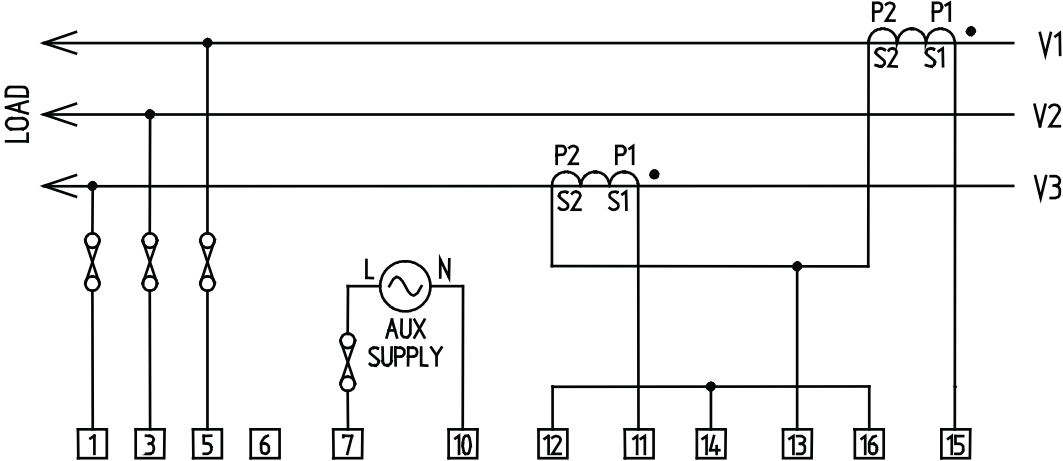

Figure 4-2 3-Phase 3-Wire 2CTs

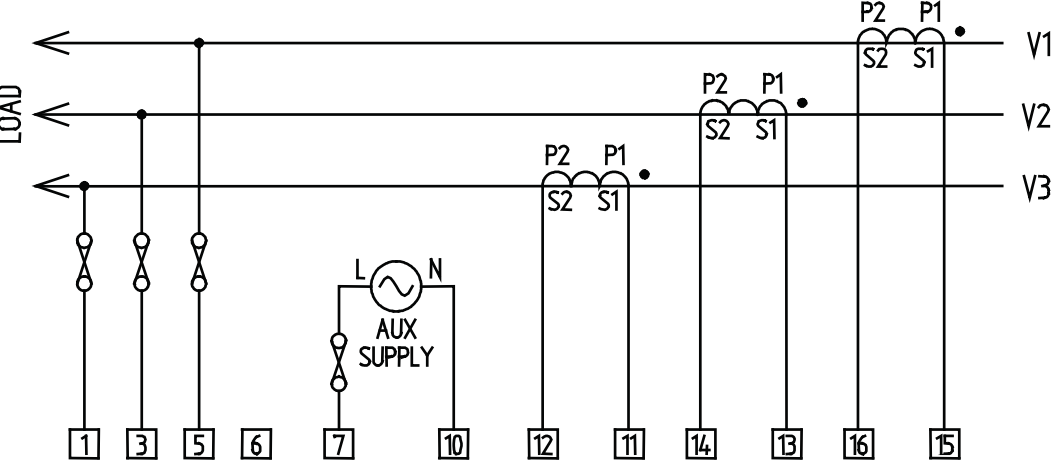

Figure 4-3 3-Phase 3-Wire 3CTs (See Note 2)

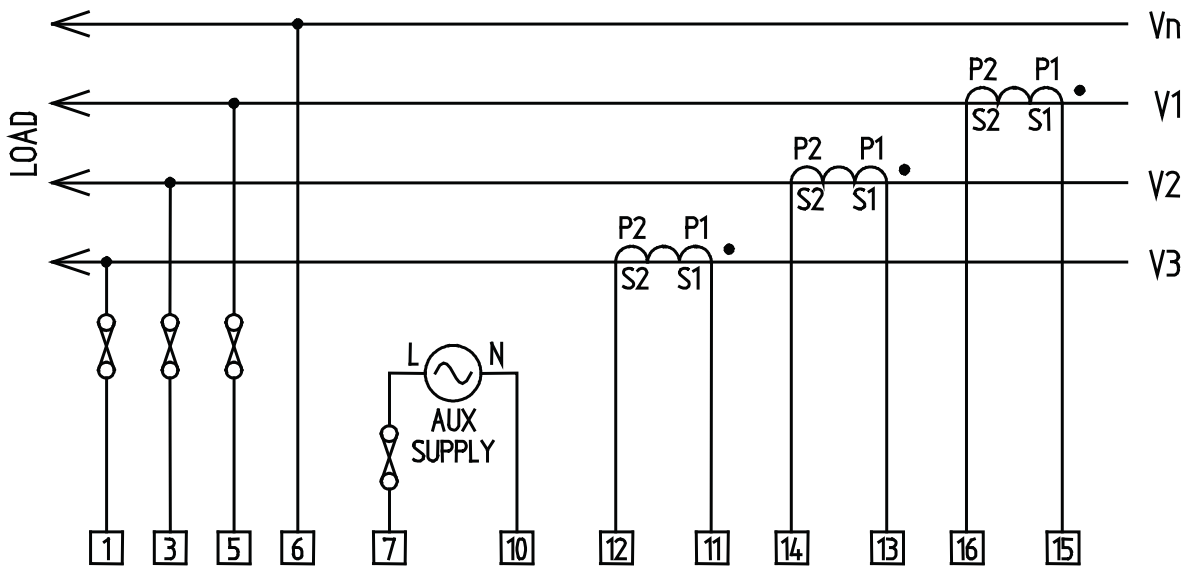

Figure 4-4 3-Phase 4-Wire (See Note 2)

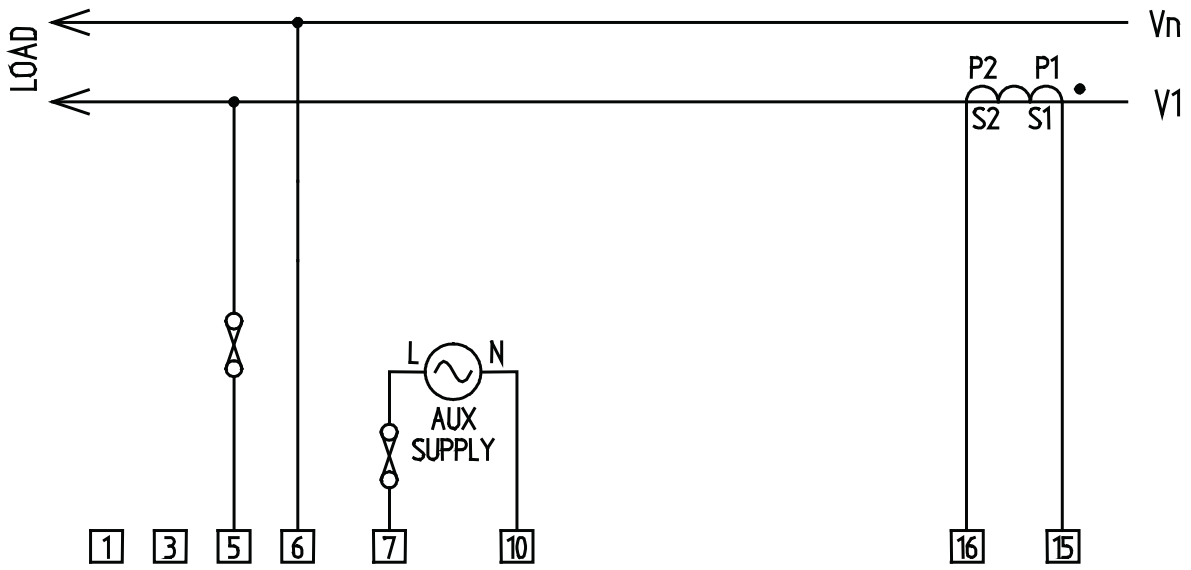
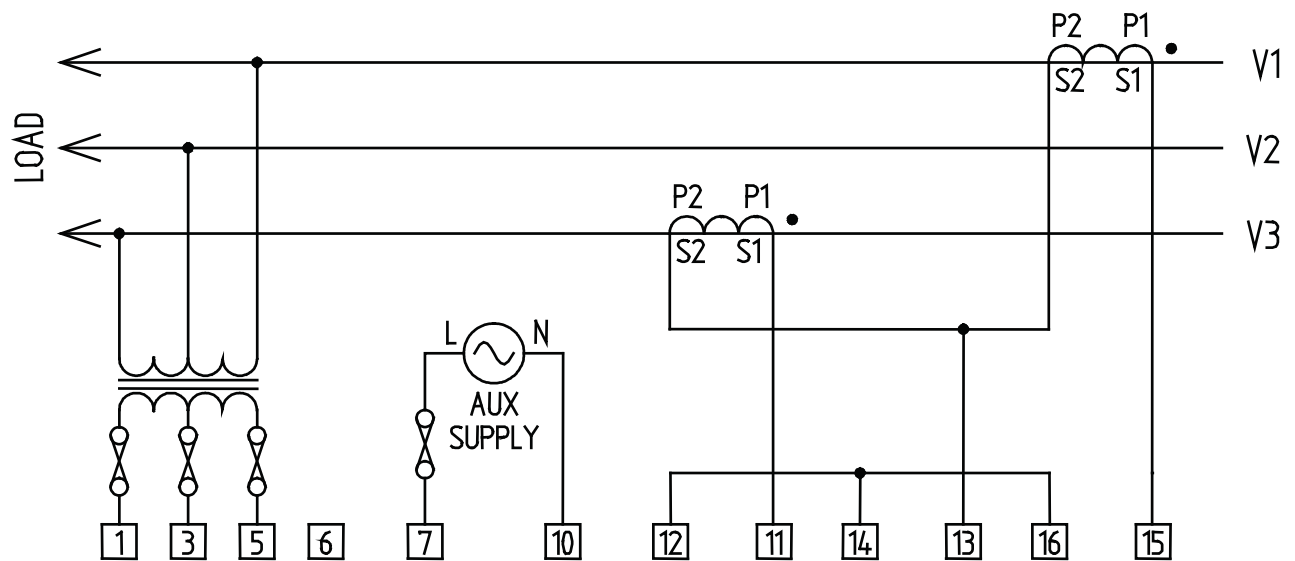

Figure 4-5 Single Phase



**Figure 4-6 3 Phase 3 Wire Using Potential Transformers (2CTs)**

**Note 1:** It is possible to use 3 current transformers in conjunction with potential transformers. Refer to Figure 4-3 for details of CT connection.

**Note 2:** Some systems require the S2 terminals of each CT to be connected to common point. This common point may be earthed. The GIMA has isolated CT inputs facilitating this type of connection.

## 5. Meter Setup

### 5.1 Programming Menu

*To enter programming mode:*

Hold **AMPS** and **SCROLL** together for 5 Seconds.  
Press SCROLL button twice to go to the next menu.

#### 4-Digit Security Code

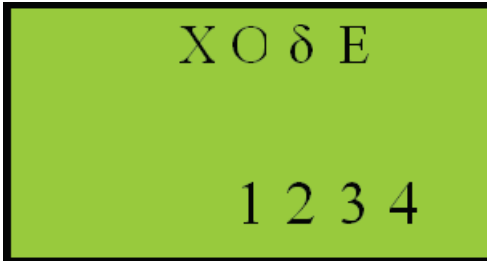

This page is only shown if a *security code* greater than 0 is set via serial communication.

Press ▲ or ▼ to select each digit (least significant first)

Press ← to move to the next most significant digit.

A correct 4 digit security code is required to access other programming menu pages.

#### Current Transformer Primary

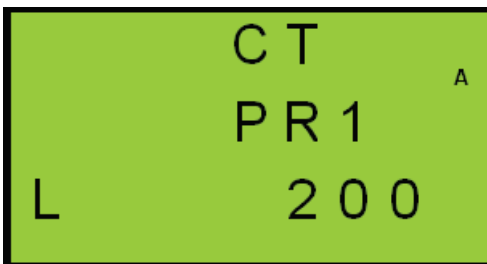

Press ▲ or ▼ to select from the standard list of CT primaries while Δ is displayed. (List Mode)

Press ▲ or ▼ to increase or decrease the value by 10 while F is displayed. (Fine adjust)

Press ← and ▲ together to toggle between L and F.

Press → to accept the set value. CT values range from 5A 25000A

#### Potential Transformer Primary

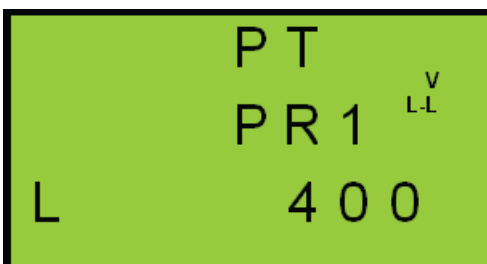

Press ▲ or ▼ to select from the standard list of PT primaries while F is displayed. (List Mode)

Press ▲ or ▼ to increase or decrease the value by 10 while F is displayed. (Fine adjust)

Press ← and ▲ together to toggle between L and F.

Press → to accept the set value. PT values range from 10V to 440kV.

### **Pulse Rate**



This sets the amount of energy (kWh) required to trigger each Pulse 1 output. Pulse 2 is set at the same rate but linked to a different register (eg kvarh). Press ▲ or ▼ to select the next/previous Pulse Rate from a standard list. Press  to accept the set value.

### **Pulse Length**

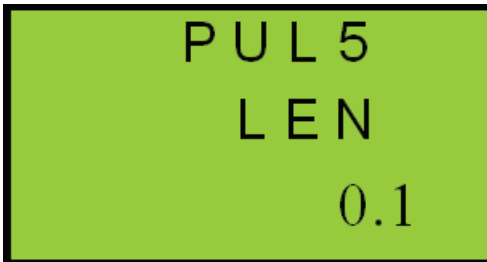

This sets the contact closure time in seconds for both pulse outputs. Press ▲ or ▼ to select the next/previous Pulse Length from a standard list between 0.1 and 20 seconds. Press  to accept the set value. Pulse lengths range from 0.1S to 20.0S.

**Note: Ensure pulse length < maximum pulse rate in seconds**

### **Current/Voltage Time Ave Period** (Note 1)



This sets the integration period in seconds used for the sliding time window average calculation for current and voltage. Press ▲ or ▼ to increment or decrement the value. Press  to accept the set value. The Time Average period may be set in the range 10 – 2500S In steps of 10 Seconds.

## Power MD Integration Period

(Note 1)

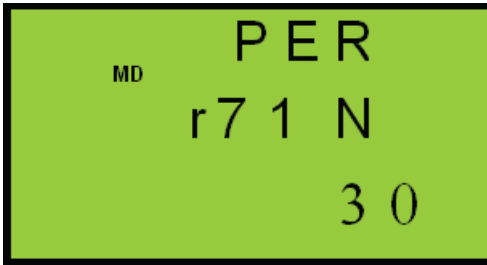

This sets the integration period in minutes used for the sliding time window MD calculation for power.

Press ▲ or ▼ to increment or decrement the value.

Press  to accept the set value.

The MD Integration period may be set in the range 1 – 60 minutes in steps of 1 minute.

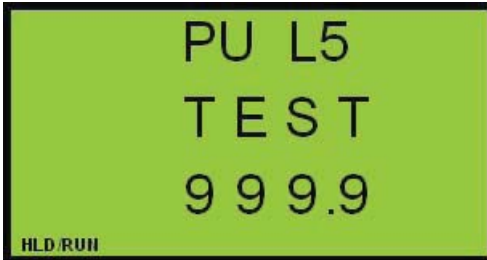

This sets the instantaneous system kW level above which the Hours Run timer will accumulate.

Below this level Hours Run will remain unchanged.

Press ▲ or ▼ to increment or decrement the value. The speed of change will increase as the button is held.

Press  to accept the set value.

**Note 1.** Some setup screens are only available on meters with corresponding measurement options.

## 6. Options

### 6.1 Internal Modbus Communications

The GIMA may be supplied with RS485 Modbus communications. This is available as a factory fitted internal option.

## 7. Specification

Inputs	
<b>System</b>	3-Phase 3 or 4 Wire Unbalanced Load
<b>Voltage</b>	Vb. 230 / 400 Volt. 3-Phase 3 or 4 Wire Vb. 63 / 110 Volt optional Vb. 120 / 208 Volt optional
<b>Current</b>	Ib 5 Amp from external current transformers (CTs) Ib 1 Amp optional Fully Isolated (2.2kV each phase)
<b>Measurement Range</b> <b>Voltage</b> <b>Current</b>	20% to 120% 0.5% to 120%
<b>Frequency Range</b> <b>Fundamental</b> <b>Harmonics</b>	45 to 65Hz Up to 30th harmonic
<b>Input Loading</b> <b>Voltage</b> <b>Current</b>	Less than 0.1 VA per phase Less than 0.1 VA per phase
<b>Overloads</b> <b>Voltage</b> <b>Current</b>	x2 for 2 seconds maximum (CAT III) x40 for 0.5 seconds maximum

Auxiliary Supply	
<b>Standard</b>	230 Volt 50/60Hz $\pm 15\%$ Overload CAT III
<b>Options</b>	110 Volt 50/60Hz $\pm 15\%$
<b>Load</b>	3 VA Maximum
<b>Isolation</b>	2.2kV (1 minute)

Display	
<b>Display Type</b>	Custom, supertwist, LCD with LED backlight
<b>Data Retention</b>	10 years minimum Stores energy registers, user settings, peaks and Hours Run
<b>Display Format</b> <b>Display Update</b>	2 Rows x 4 Digits, 1 Row x 8 Digits + Legends 1 second

Digital (Pulse) Outputs	
<b>Function</b>	1 pulse / energy unit (Output #1=N Wh, Output #2=N varh)
<b>Scaling</b>	Programmable
<b>Pulse Period</b>	Programmable 100ms minimum. (2ms Rise, 2ms Fall)
<b>Type</b>	N/O Volt free contact. Optically isolated BiFET
<b>Contacts</b>	100mA AC/DC max, 100V AC/DC max
<b>Isolation</b>	2.2kV (50V #1 to #2)

Accuracy	
<b>Phase Current</b>	0.2% Ib (1.0% Rdg. 0.05 Ib ≤ Iph ≤ 1.2 Ib) ±1 digit.
<b>Neutral Current</b>	0.6% Ib (2.0% Rdg. 0.05 Ib ≤ In ≤ 1.2 Ib) ±1 digit.
<b>Phase Voltage</b>	0.2% Vb (1.0% Rdg. 0.2 Vb ≤ Vph ≤ 1.2 Vb) ±1 digit.
<b>Line-Line Voltage</b>	0.3% Vb (1.0% Rdg. 0.2 Vb ≤ VLL ≤ 1.2 Vb) ±1 digit.
<b>Phase Watts</b>	0.4% FS (1.0% Rdg. 0.05FS ≤ P ≤ 1.2FS) ±1 digit.
<b>Phase VA</b>	0.6% FS (1.5% Rdg. 0.05FS ≤ Q ≤ 1.2FS) ±1 digit.
<b>Phase var</b>	0.8% FS (2.0% Rdg. 0.05FS ≤ S ≤ 1.2FS) ±1 digit.
<b>Phase PF</b>	± 0.2 Degrees
<b>System Watts</b>	0.6% FS (1.0% Rdg. 0.05FS ≤ P ≤ 1.2FS) ±1 digit.
<b>System VA</b>	1.0% FS (1.5% Rdg. 0.05FS ≤ Q ≤ 1.2FS) ±1 digit.
<b>System var</b>	1.5% FS (2.0% Rdg. 0.05FS ≤ S ≤ 1.2FS) ±1 digit.
<b>System PF</b>	± 0.2 Degrees
<b>Frequency</b>	±0.05Hz. 45Hz ≤ F ≤ 65Hz
<b>Wh Register</b>	Class 1.0 EN 61036, EN 62053-21, BS 8431
<b>VAh Register</b>	Class 2.0
<b>varh Registers</b>	Class 2.0 IEC 1268, EN 60253-23, BS 8431
<b>% THD Amps</b>	± 0.5% THD 0.05 Ib ≤ Iph ≤ 1.2 Ib
<b>% THD Volts</b>	± 0.5% THD 0.2 Vb ≤ Vph ≤ 1.2 Vb
<b>Timebase</b>	Better than 100ppm

General	
<b>Temperature Operating Storage</b>	-10 deg C to +65 deg C -25 deg C to +70 deg C
<b>Environment</b>	IP54
<b>Humidity</b>	<75% non-condensing

Mechanical	
<b>Enclosure</b>	DIN 96mm x 96mm Mablex ULV94-V-O
<b>Dimensions</b>	96mm x 96mm x 80mm (72mm behind panel) 130mm behind panel with options unit fitted
<b>Weight</b>	Approx. 400g
<b>Terminals</b>	Rising Cage. 4.0mm <sup>2</sup> cable max